



VIGOR

VIGOR POOL & SPA

PIKES

POOL & SPA

2023-2024

广东卡丹丽泳池水疗设备有限公司
GUANGDONG KASDALY POOL SPA EQUIPMENT CO.,LTD

工厂地址: 广东省清远市高新区龙塘镇泛宇工业区A地
Factory ADD: Fanyu Industrial Estate, Longtang Town, Qingyuan City, Guangdong, China
电话-Tel: 0763-3603028 / 3603098 传真-Fax: 0763-3603098
网址-Web: www.joyspagroup.com 邮箱-E-mail: info@joyspa.com.cn

营销总部: 广州市白云区尖彭路395号天瑞广场B座1601-1625
Office ADD: 16/F Building B, Tianrui Plaza, NO.395 Jianpeng Road, Baiyun, Guangzhou city, China

电话-Tel: +86-20-81007588 / 81962303 / 36551701 / 36551957 邮箱-E-mail: sales@pikespool.com
网址-Web: www.pikespool.com

www.pikespool.com

广东卡丹丽泳池水疗设备有限公司
2023-2024

企业介绍

威格国际（广州公司）成立于1999年，旗下工厂（广东卡丹丽泳池水疗设备有限公司）成立于2011年，是一家专业生产泳池过滤设备、SPA户外按摩浴缸、水疗、蒸汽、桑拿设备的生产型企业。坐落于风景秀丽的广东省清远市高新区，占地面积23000平米，公司于2018年通过广东省高新技术企业认定，目前拥有专利11项，企业以自主品牌“JOYSPA”“PIKES”“三T”为主，通过ISO9001体系认证，欧盟CE认证，GS认证，澳洲SAA认证，尼日利亚SON认证；产品远销欧美，中东，非洲，亚洲等世界各地。

工厂拥有自动化生产设备，采用国内外先进技术及设备，研发及推出各种独特、新颖的产品来满足不同市场的需求。

企业秉承“卓越、诚信、创新、共赢”的经营理念为客户提供行业最专业的泳池、SPA等水疗设备。不断打造并树立行业知名品牌及企业形象。欢迎各届人士莅临指导。

COMPANY

GUANGZHOU VIGOR COMPANY is founded in 1999, which is a professional manufacturer for swimming pool filters, outdoor hot tubs, SPA, steam and sauna equipment. There are brands of “JOYSPA”, “PIKES”, “三T”.

GUANGDONG KASDALY POOL SPA EQUIPMENT CO.,LTD for many years to “excellence, integrity, innovation, win-win” business development ideas, has through ISO9001 system certification, the EU CE certification, GS certification, Australia SAA certification, Nigeria SONCAP certification. Our company also has professional products technical development team, marketing team and excellent after-sales service team; The products are mainly exported to Europe, America, Middle East, central Asia, Africa and other countries, which has already won domestic and foreign customers trust and praise.

Meanwhile, Vigor Group, holding on ideal development of Strives for customer first and sustainable innovation, continuously has developed unique and innovative products to cater for the different demand of markets, so that we can do well and supply professional swimming pool, SPA and other equipment for our customers. Sincerely hope the common development of all partners.

目录 CONTENT

壁挂式一体化过滤器 Wall-mounted Filter	01 - 11	池面设备 Pool Surrounding Accessories	71-80
地埋式一体化过滤器 Inground Filter	12 - 24	不锈钢扶梯系列 Ladder Series	81-84
过滤器系列 Sand Filter Series	25 - 32	清洁工具 Cleaning Equipment	85-89
水泵系列 Pump Series	33 - 40	桑拿系列 Sauna Series	90-102
水下灯系列 Underwater Light Series	41 - 50	蒸汽系列 Steam Room Series	103-107
水疗系列 SPA Series	51 - 59	户外家具系列 Leisure Furniture Series	108 - 109
泳池机房设备 Machine Room Equipment	60-70	SPA浴缸系列 Spa Hot Tub Series	110 - 120



壁挂式一体化过滤器 Wall-mounted Filter



壁挂式一体化过滤器 Wall-mounted Filter



Model:PK8020(儿童池专用 Children Swimming Pool)

一体化过滤器采用优质的亚克力原料做外壳，其耐酸性能好，易清洗，不易褪色；一体化过滤器安装无需机房，安装简单，操作方便，性能优异，从而减低施工成本。同时一体化过滤器符合国家泳池规范和标准。

The enclosure of wall-mounted filter is made of high quality Acrylic, so the filter is anti-acid anti-fading, and easy to clean. Integrated filter installation without room, simple installation, convenient operation, excellent performance, thereby reducing the construction cost. The filter is made according to Countries codes and standards.

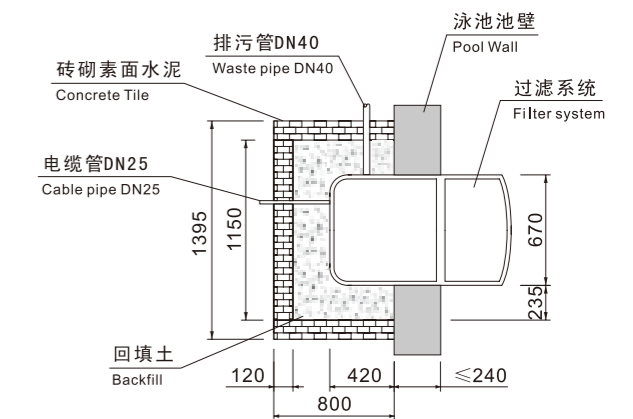
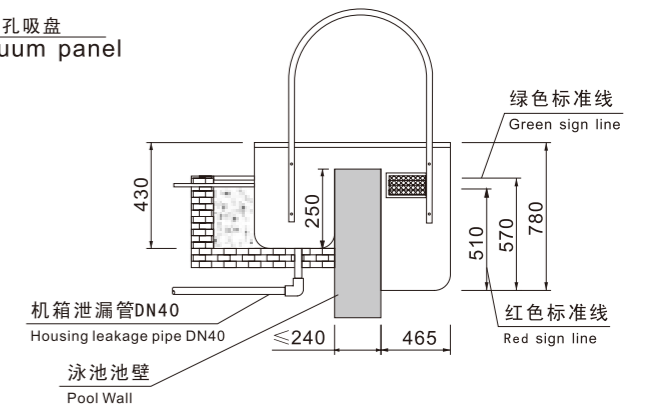
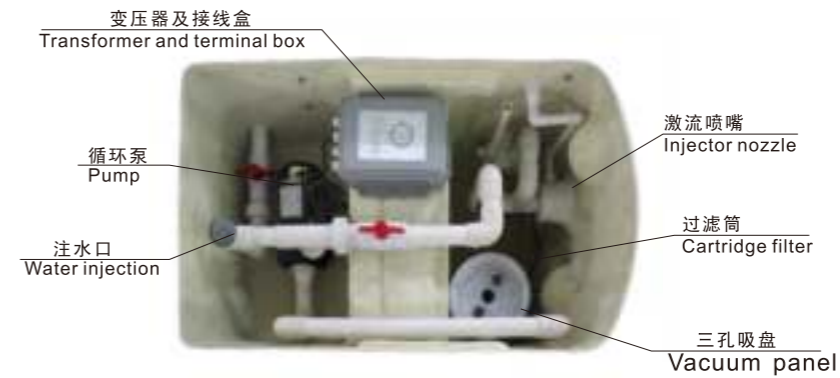

技术参数 TECHNICAL CHARACTERISTICS

Dimensions 尺寸	1110x 670x 780mm
Flow rate 流量	10m ³ /h 15m ³ /h
Voltage 电压	220V / 50Hz or 60Hz
Precision of filtration bag 过滤精度	≤5u
Operating noise 运行噪音	≤50Db
Material 材料	Acrylic
Installation 安装方式	Wall mounted

设备配置 EQUIPMENT

Filtration Pump 过滤泵	1x1HP	1x1.5HP
Filtration basket with bag 过滤袋	1pc	
Chlorine feeder 投药器	1pc	
Light 灯 (Warm white)	1x LED	12W / 12V
Time controller 定时控制器	1pc	
Swim jet 喷嘴	2pcs	
Handle rail (S.S.) 扶手	2pcs	
Ozone(optional) 臭氧	1pc	选配 (options)

设备系统 SYSTEM

Filtration system 过滤系统	1pc
Disinfection system 消毒系统	1pc
Time control system 定时系统	1pc
Circle system 循环系统	1pc
Lighting system 照明系统	1pc

Model:PK8025

一体化过滤器采用优质的亚克力原料做外壳，其耐酸性能好，易清洗，不易褪色；一体化过滤器安装无需机房，安装简单，操作方便，性能优异，从而减低施工成本。同时一体化过滤器符合国家泳池规范和标准。

The enclosure of wall-mounted filter is made of high quality Acrylic, so the filter is anti-acid anti-fading, and easy to clean. Integrated filter installation without room, simple installation convenient operation, excellent performance, thereby reducing the construction cost. The filter is made according to Countries codes and standards.

- 1、不锈钢扶手 Stainless-steel hand rail
- 2、电缆管 Cable pipe
- 3、变压器及接线盒 Transformer and terminal box
- 4、排污管 Sewage pipe
- 5、带过滤筒 Cartridge filter
- 6、消毒器 Sterilizer
- 7、激流喷嘴 Injector nozzle
- 8、泳池灯 Swimming pool lamp
- 9、进水口 Water inlet
- 10、出水口 Water outlet
- 11、现场活动围板 Hoarding
- 12、混凝土 Concrete
- 13、池边砖 Poolside tile

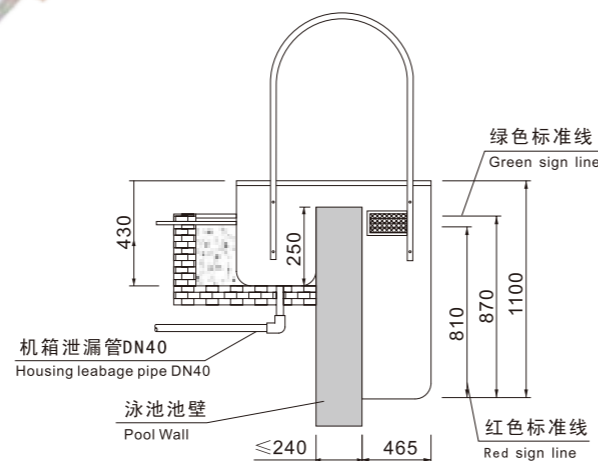
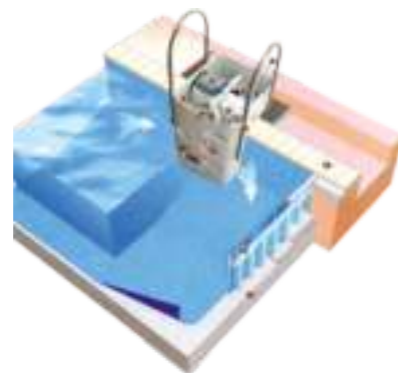

技术参数 TECHNICAL CHARACTERISTICS

Dimensions 尺寸	1120x 690x 1100mm
Flow rate 流量	25m ³ /h
Voltage 电压	220V / 50Hz or 60Hz
Precision of filtration bag 过滤精度	≤5u
Operating noise 运行噪音	≤50Db
Material 材料	Acrylic
Installation 安装方式	Wall mounted

设备配置 EQUIPMENT

Filtration Pump 过滤泵	1x2HP
Filtration basket with bag 过滤袋	1pc
Chlorine feeder 投药器	1pc
Light 灯 (Warm white)	1x LED 12W / 12V
Time controller 定时控制器	1pc
Swim jet 喷嘴	2pcs
Handle rail (S.S.) 扶手	2pcs
Ozone(optional) 臭氧	1pc 选配(options)

设备系统 SYSTEM

Filtration system 过滤系统	1pc
Disinfection system 消毒系统	1pc
Time control system 定时系统	1pc
Circle system 循环系统	1pc
Lighting system 照明系统	1pc

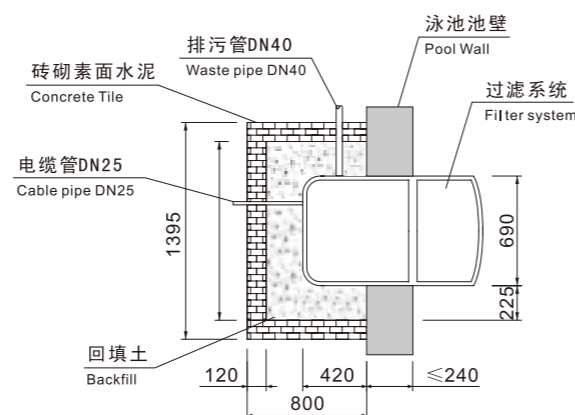

Model:PK8022

一体化过滤器采用ABS材料做外壳，其耐酸性能好，易清洗，不易褪色；一体化过滤器安装无需机房，安装简单，操作方便，性能优异，从而减低施工成本。同时一体化过滤器符合国家泳池规范和标准。

The enclosure of wall-mounted filter is made of ABS, so the filter is anti-acid anti-fading, and easy to clean. Integrated filter installation without room, simple installation convenient operation, excellent performance, thereby reducing the construction cost. The filter is made according to Countries codes and standards.



技术参数 TECHNICAL CHARACTERISTICS

Dimensions 尺寸	1450x530x1060mm
Flow rate 流量	25m ³ /h
Voltage 电压	220V / 50Hz or 60Hz
Precision of filtration bag 过滤精度	≤5u
Operating noise 运行噪音	≤50Db
Material 材料	ABS
Installation 安装方式	Wall mounted

设备配置 EQUIPMENT

Filtration Pump 过滤泵	1x2HP
Filtration basket with bag 过滤袋	1pc
Light 灯 (Warm white)	1x LED 12W / 12V
Time controller 定时控制器	1pc
Swim jet 喷嘴	2pcs
Ozone(optional) 臭氧	1pc

设备系统 SYSTEM

Filtration system 过滤系统	1pc
Disinfection system 消毒系统	1pc
Time control system 定时系统	1pc
Circle system 循环系统	1pc
Lighting system 照明系统	1pc

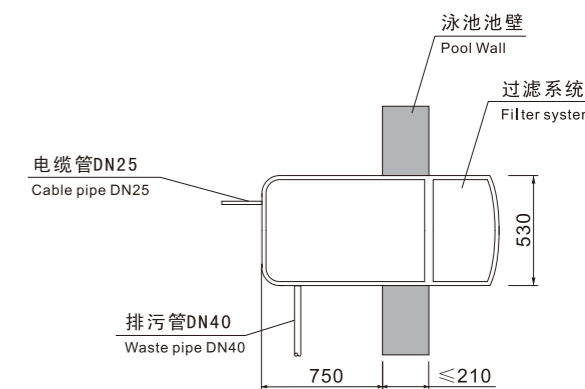
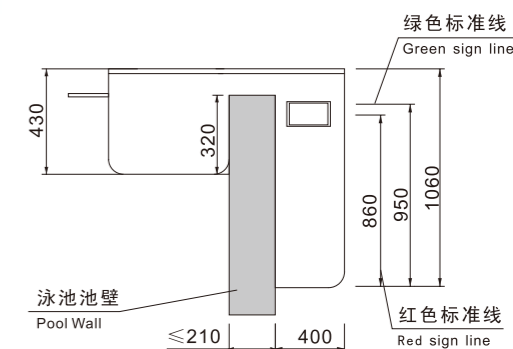

Model:PK8026

一体化过滤器采用优质的亚克力原料做外壳，其耐酸性能好，易清洗，不易褪色；一体化过滤器安装无需机房，安装简单，操作方便，性能优异，从而减低施工成本。同时一体化过滤器符合国家泳池规范和标准。

The enclosure of wall-mounted filter is made of high quality Acrylic, so the filter is anti-acid anti-fading, and easy to clean. Integrated filter installation without room, simple installation, convenient operation, excellent performance, thereby reducing the construction cost. The filter is made according to Countries codes and standards.

技术参数 TECHNICAL CHARACTERISTICS

Dimensions 尺寸	1150x 710x 1090mm	
Flow rate 流量	25m ³ /h	35m ³ /h
Voltage 电压	220V / 50Hz or 60Hz	
Precision of filtration bag 过滤精度	≤5u	
Operating noise 运行噪音	≤50Db	
Material 材料	Acrylic	
Installation 安装方式	Wall mounted	

设备配置 EQUIPMENT

Filtration Pump 过滤泵	1x2HP	1x3HP
Filtration basket with bag 过滤袋	1pc	2pcs
Chlorine feeder 投药器	1pc	
Light 灯 (Warm white)	1x LED	12W / 12V
Time controller 定时控制器	1pc	
Swim jet 喷嘴	2pcs	
Handle rail (S.S.) 扶手	2pcs	
Ozone(optional) 臭氧	1pc	选配 (options)

设备系统 SYSTEM

Filtration system 过滤系统	1pc
Disinfection system 消毒系统	1pc
Time control system 定时系统	1pc
Circle system 循环系统	1pc
Lighting system 照明系统	1pc

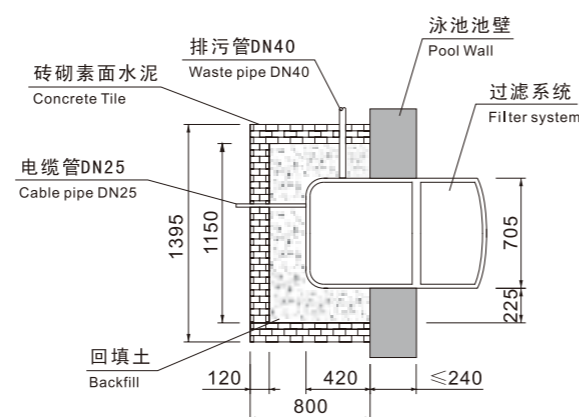
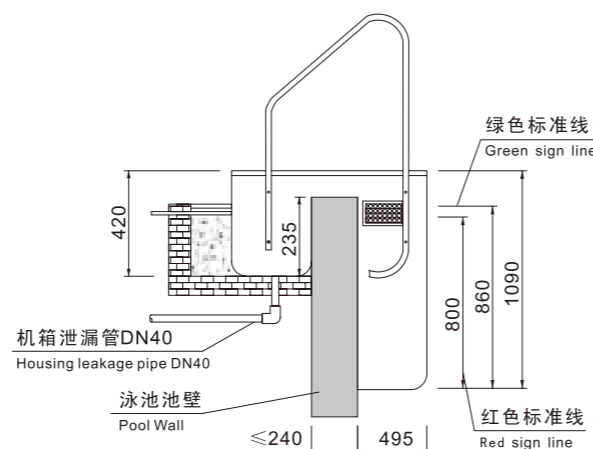

Model:PK8028

一体化过滤器采用优质的亚克力原料做外壳，其耐酸性能好，易清洗，不易褪色；一体化过滤器安装无需机房，安装简单，操作方便，性能优异，从而减低施工成本。同时一体化过滤器符合国家泳池规范和标准。

The enclosure of wall-mounted filter is made of high quality Acrylic, so the filter is anti-acid anti-fading, and easy to clean. Integrated filter installation without room, simple installation, convenient operation, excellent performance, thereby reducing the construction cost. The filter is made according to Countries codes and standards.

技术参数 TECHNICAL CHARACTERISTICS

Dimensions 尺寸	1150x 710x 1090mm	
Flow rate 流量	25m ³ /h	35m ³ /h
Voltage 电压	220V / 50Hz or 60Hz	
Precision of filtration bag 过滤精度	≤5u	
Operating noise 运行噪音	≤50Db	
Material 材料	Acrylic	
Installation 安装方式	Wall mounted	

设备配置 EQUIPMENT

Filtration Pump 过滤泵	1x2HP	1x3HP
Filtration basket with bag 过滤袋	1pc	2pcs
Chlorine feeder 投药器	1pc	
Light 灯 (Warm white)	1x LED	12W / 12V
Time controller 定时控制器	1pc	
Swim jet 喷嘴	2pcs	
Handle rail (S.S.) 扶手	2pcs	
Ozone(optional) 臭氧	1pc	选配 (options)

设备系统 SYSTEM

Filtration system 过滤系统	1pc
Disinfection system 消毒系统	1pc
Time control system 定时系统	1pc
Circle system 循环系统	1pc
Lighting system 照明系统	1pc



Pikes POOL&SPA® 壁挂式一体化过滤器 Wall-mounted Filter

Model:PK8023

一体化过滤器采用优质的亚克力原料做外壳，先进的工艺一次成型，美观耐用；一体化过滤器改变了传统的安装模式，无需机房，安装简单，操作方便，性能优异，从而减低施工成本。同时一体化过滤器符合国家泳池规范和标准。

The enclosure of wall-mounted filter is made of high quality Acrylic. The wall-mounted filter is change to traditional sand filter. Now the filter installation without room, simple installation, convenient operation, excellent performance, thereby reducing the construction cost. The filter is made according to Countries codes and standards.

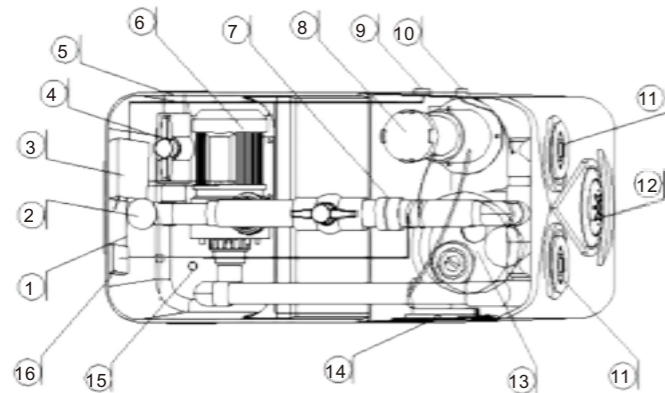

- | | |
|------------------------------------|----------------------------------|
| 1.设备箱体 filter shell | 10.空气开关 air controller on/off |
| 2.注水器 water injector | 11.冲浪喷嘴 spa jet |
| 3.控制电箱 control box | 12.节能水底灯 pool light |
| 4.排水阀门 drain valve | 13.前置过滤器 water filter |
| 5.排水口 drain water pipe | 14.进水口 water inlet |
| 6.水泵 water pump | 15.压力溢水口 pressure water purifier |
| 7.活动连接器 active connector | 16.臭氧消毒器 Ozone disinfection |
| 8.氯丸消毒器 chlorinator feeder | |
| 9.制动器开关 make air controller on/off | |

技术参数 TECHNICAL CHARACTERISTICS

Dimensions 尺寸	1050x550x860mm
Flow rate 流量	10m ³ /h
Voltage 电压	220V / 50Hz / 60Hz
Precision of filtration bag 过滤精度	≤5u
Operating noise 运行噪音	≤50Db
Material 材料	Acrylic
Installation 安装方式	Wall mounted

设备配置 EQUIPMENT

Filtration Pump 过滤泵	1x1HP
Filtration basket with bag 过滤袋	1pc
Chlorine feeder 投药器	1pc
Light 灯 (Warm white)	1xLED 12W / 12V
Time controller 定时控制器	1pc
Swim jet 喷嘴	2pcs
Ozone(optional) 臭氧	1pc 选配(options)

设备系统 SYSTEM

Filtration system 过滤系统	1pc
Disinfection system 消毒系统	1pc
Time control system 定时系统	1pc
Circle system 循环系统	1pc
Lighting system 照明系统	1pc

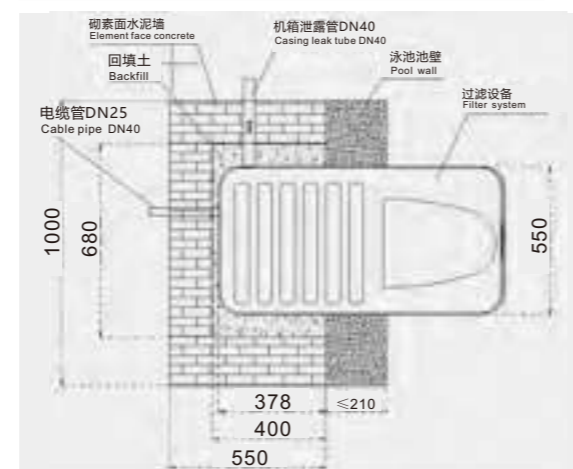
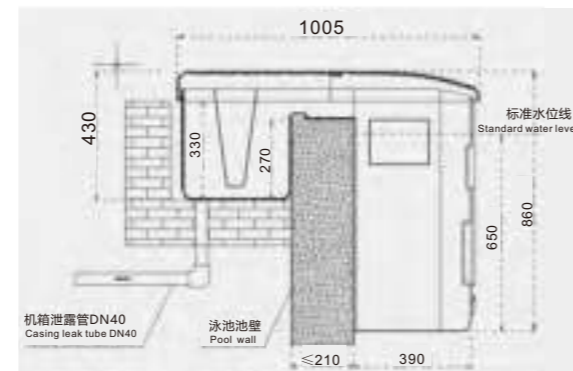

嵌入式一体化过滤器 Inground Filter

Model:PK8030

一体化过滤器采用优质的亚克力原料做外壳，其耐酸性能好，易清洗，不易褪色；一体化过滤器安装无需机房，安装简单，操作方便，性能优异，从而减低施工成本。8个过滤袋流量大。

The enclosure of wall-mounted filter is made of high quality Acrylic, so the filter is anti-acid anti-fading, and easy to clean. Integrated filter installation without room, simple installation, convenient operation, excellent performance, thereby reducing the construction cost. It's big flow rate for 8pcs filter bag.

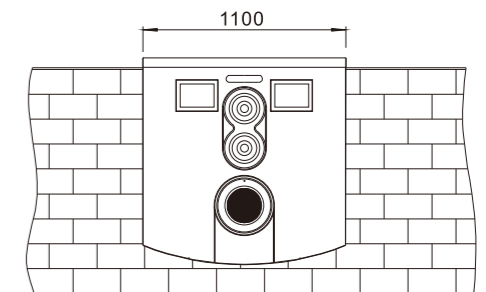
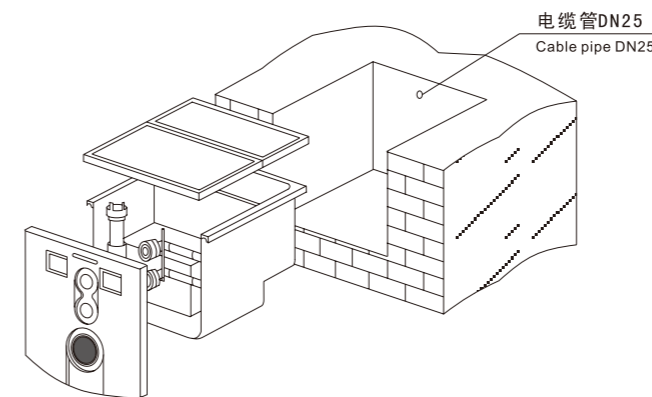

技术参数 TECHNICAL CHARACTERISTICS

Dimensions 尺寸	1100x1200x1120mm
Flow rate 流量	47m ³ /h
Voltage 电压	220V / 50Hz or 60Hz
Precision of filtration bag 过滤精度	≤5u
Operating noise 运行噪音	≤50Db
Material 材料	Acrylic
Installation 安装方式	Inground

设备配置 EQUIPMENT

Filtration Pump 过滤泵	1x4HP
Filtration basket with bag 过滤袋	8pc
Chlorine feeder 投药器	1pc
Light 灯 (Warm white)	1x LED 12W / 12V
Time controller 定时控制器	1pc
Swim jet 喷嘴	2pcs x 5"

设备系统 SYSTEM

Filtration system 过滤系统	1pc
Disinfection system 消毒系统	1pc
Time control system 定时系统	1pc
Circle system 循环系统	1pc
Lighting system 照明系统	1pc

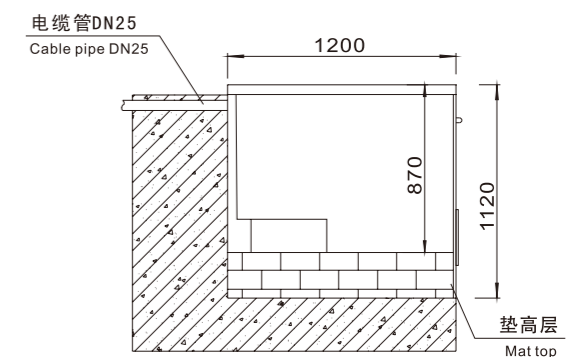
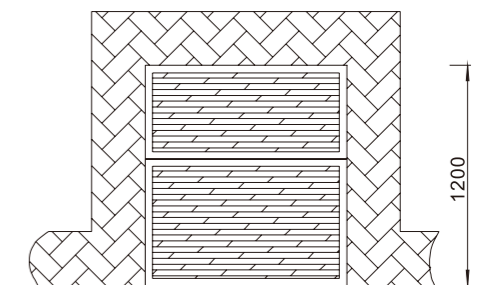

Pikes POOLASPA® 壁挂式一体化过滤器 Wall-mounted Filter

Model:PK8021(儿童池专用 Children Swimming Pool)

一体化过滤器采用优质的聚氯乙烯原料做外壳，先进的工艺一次成型，美观耐用；一体化过滤器改变了传统的安装模式，无需机房，安装简单，操作方便，性能优异，从而减低施工成本。同时一体化过滤器符合国家泳池规范和标准。

The enclosure of wall-mounted filter is made of high quality Polyethylene. The wall-mounted filter is change to traditional sand filter. Now the filter installation without room, simple installation, convenient operation, excellent performance, thereby reducing the construction cost. The filter is made according to Countries codes and standards.

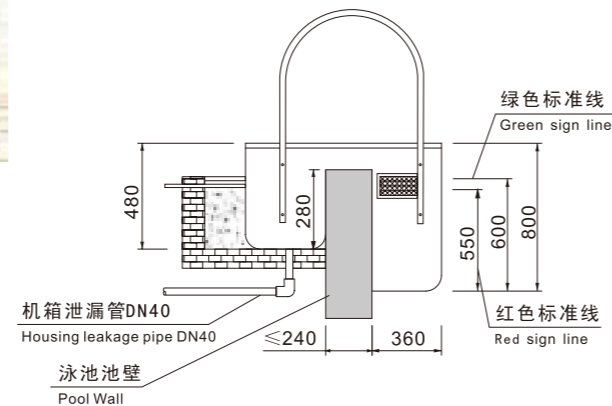

技术参数 TECHNICAL CHARACTERISTICS

Dimensions 尺寸	950x580x800mm
Flow rate 流量	15m ³ /h
Voltage 电压	220V / 50Hz or 60Hz
Precision of filtration bag 过滤精度	≤5u
Operating noise 运行噪音	≤50Db
Material 材料	Polyethylene
Installation 安装方式	Wall mounted

设备配置 EQUIPMENT

Filtration Pump 过滤泵	1x1.0HP
Filtration basket with bag 过滤袋	1pc
Chlorine feeder 投药器	1pc
Light 灯 (Warm white)	1x LED 12W/12V
Time controller 定时控制器	1pc
Swim jet 喷嘴	2pcs
Handle rail (S.S.) 扶手	2pcs
Ozone(optional) 臭氧	1pc 选配(options)

设备系统 SYSTEM

Filtration system 过滤系统	1pc
Disinfection system 消毒系统	1pc
Time control system 定时系统	1pc
Circle system 循环系统	1pc
Lighting system 照明系统	1pc

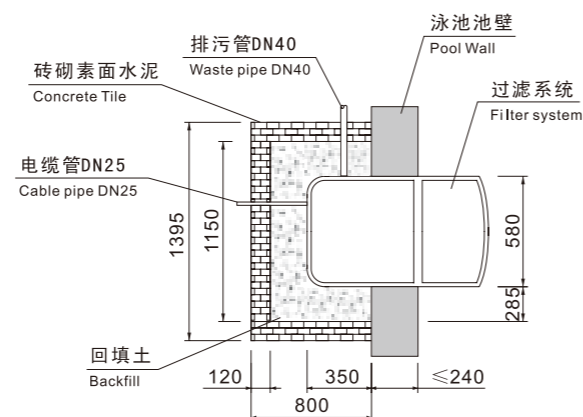

Pikes POOLASPA® 壁挂式一体化过滤器 Wall-mounted Filter

Model:PK8029

一体化过滤器采用优质的聚氯乙烯原料做外壳，先进的工艺一次成型，美观耐用；一体化过滤器改变了传统的安装模式，无需机房，安装简单，操作方便，性能优异，从而减低施工成本。同时一体化过滤器符合国家泳池规范和标准。

The enclosure of wall-mounted filter is made of high quality Polyethylene. The wall-mounted filter is change to traditional sand filter. Now the filter installation without room, simple installation, convenient operation, excellent performance, thereby reducing the construction cost. The filter is made according to Countries codes and standards.

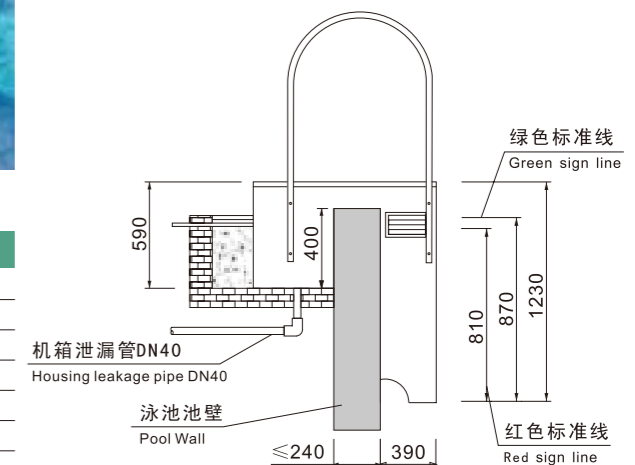

技术参数 TECHNICAL CHARACTERISTICS

Dimensions 尺寸	1095x 705x 1230mm
Flow rate 流量	25m ³ /h
Voltage 电压	220V / 50Hz or 60Hz
Precision of filtration bag 过滤精度	≤5u
Operating noise 运行噪音	≤50Db
Material 材料	Polyethylene
Installation 安装方式	Wall mounted

设备配置 EQUIPMENT

Filtration Pump 过滤泵	1x2HP
Filtration basket with bag 过滤袋	1pc
Chlorine feeder 投药器	1pc
Light 灯 (Warm white)	1x LED 12W/12V
Time controller 定时控制器	1pc
Swim jet 喷嘴	2pcs
Handle rail (S.S.) 扶手	2pcs
Ozone(optional) 臭氧	1pc 选配(options)

设备系统 SYSTEM

Filtration system 过滤系统	1pc
Disinfection system 消毒系统	1pc
Time control system 定时系统	1pc
Circle system 循环系统	1pc
Lighting system 照明系统	1pc

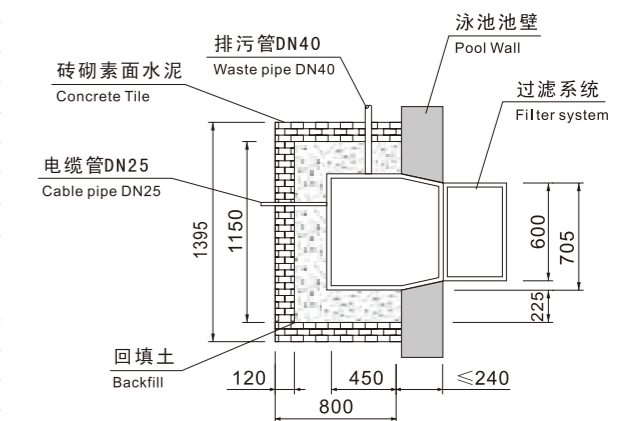

Model:PK8032

一体化过滤器采用优质的聚氯乙烯原料做外壳，先进的工艺一次成型，美观耐用；一体化过滤器改变了传统的安装模式，无需机房，安装简单，操作方便，性能优异，从而减低施工成本。同时一体化过滤器符合国家泳池规范和标准。

The enclosure of wall-mounted filter is made of high quality Polyethylene. The wall-mounted filter is change to traditional sand filter. Now the filter installation without room, simple installation, convenient operation, excellent performance, thereby reducing the construction cost. The filter is made according to Countries codes and standards.

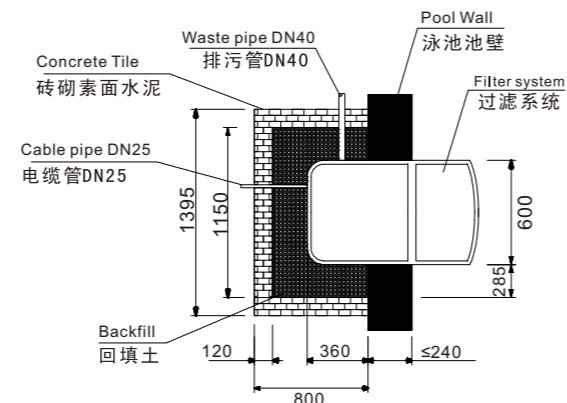
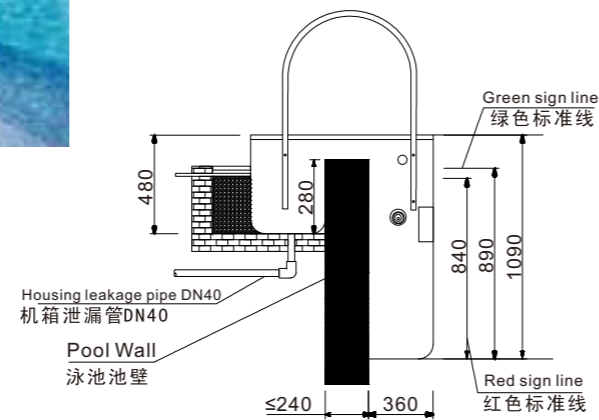

技术参数 TECHNICAL CHARACTERISTICS

Dimensions 尺寸	1090X600X960
Flow rate 流量	25m ³ /h
Voltage 电压	220V / 50Hz / 60Hz
Precision of filtration bag 过滤精度	≤5u
Operating noise 运行噪音	≤50Db
Material 材料	Polyethylene
Installation 安装方式	Wall mounted

设备配置 EQUIPMENT

Filtration Pump 过滤泵	1x2HP
Filtration basket with bag 过滤袋	1pc
Light 灯 (Warm white)	1XLED 12W / 12V
Time controller 定时控制器	1pcs
Swim jet 喷嘴	2pcs
Ozone(optional) 臭氧	1pc 选配(options)

设备系统 SYSTEM

Filtration system 过滤系统	1pc
Disinfection system 消毒系统	1pc
Time control system 定时系统	1pc
Circle system 循环系统	1pc
Lighting system 照明系统	1pc

